

HH->bbbb

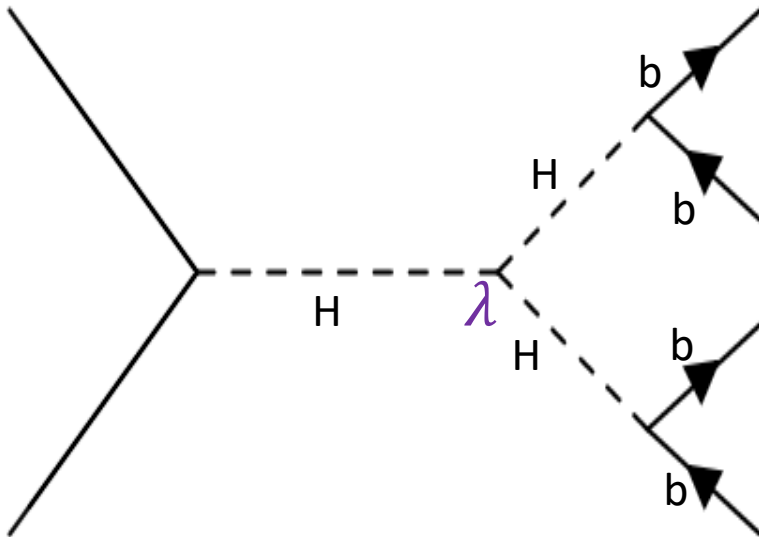

Goal: Distinguish between process with and without Higgs self-coupling



Feynman Diagram of collision process with Higgs self-coupling

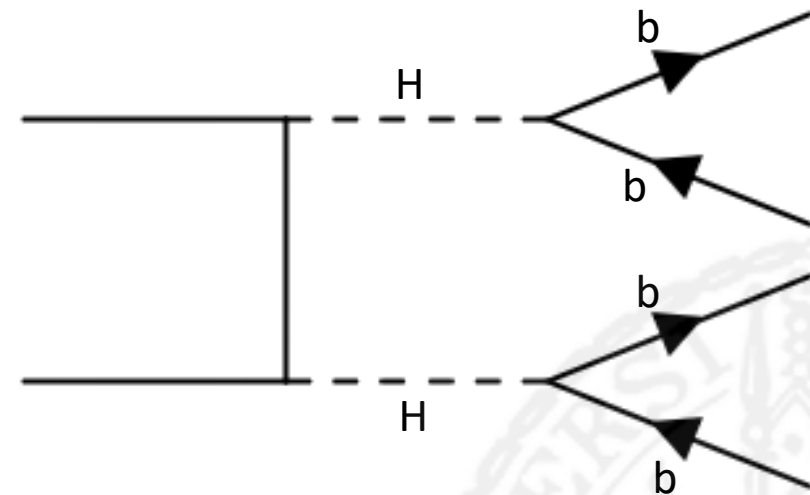

Feynman Diagram of collision process without Higgs self-coupling

Data Quality

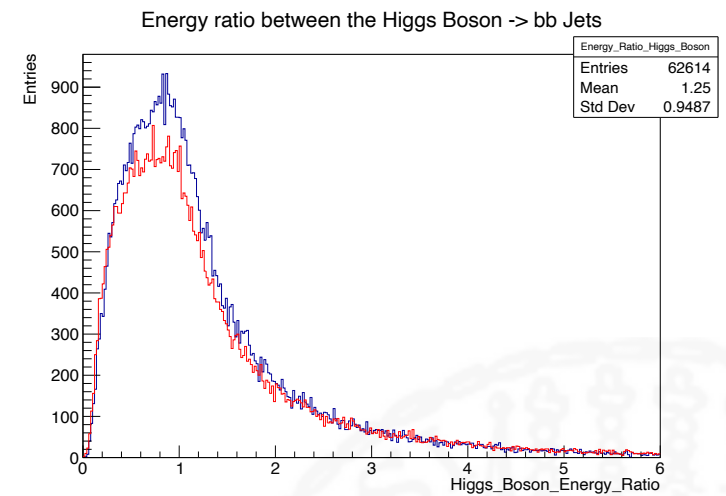
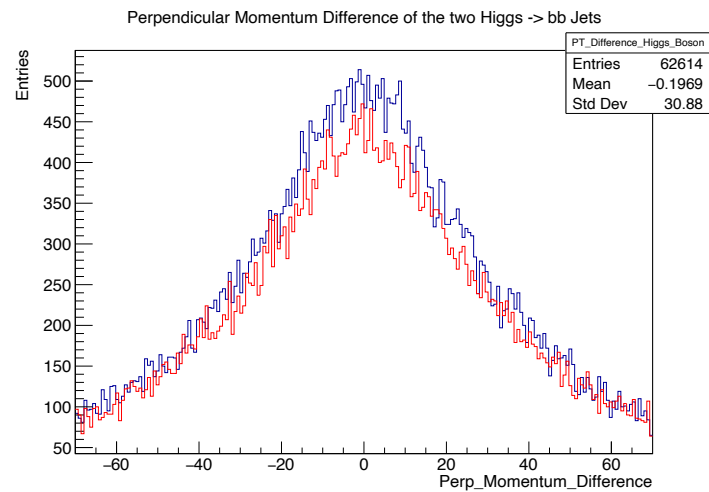
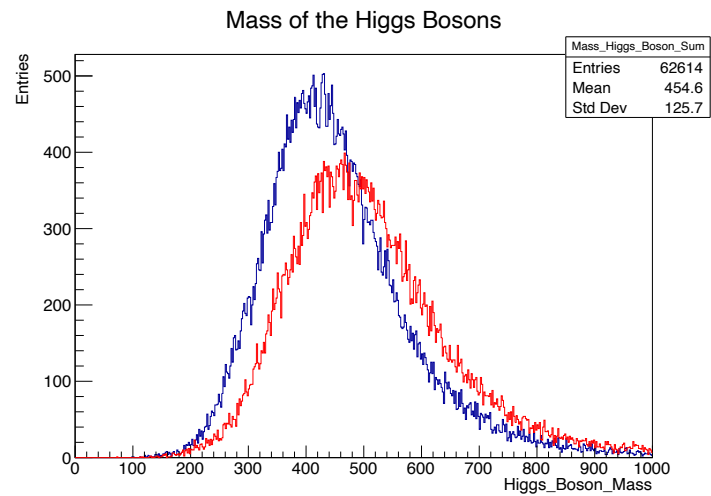

Data Quality



Mass of the Sum of the two Higgs Lorentzvectors

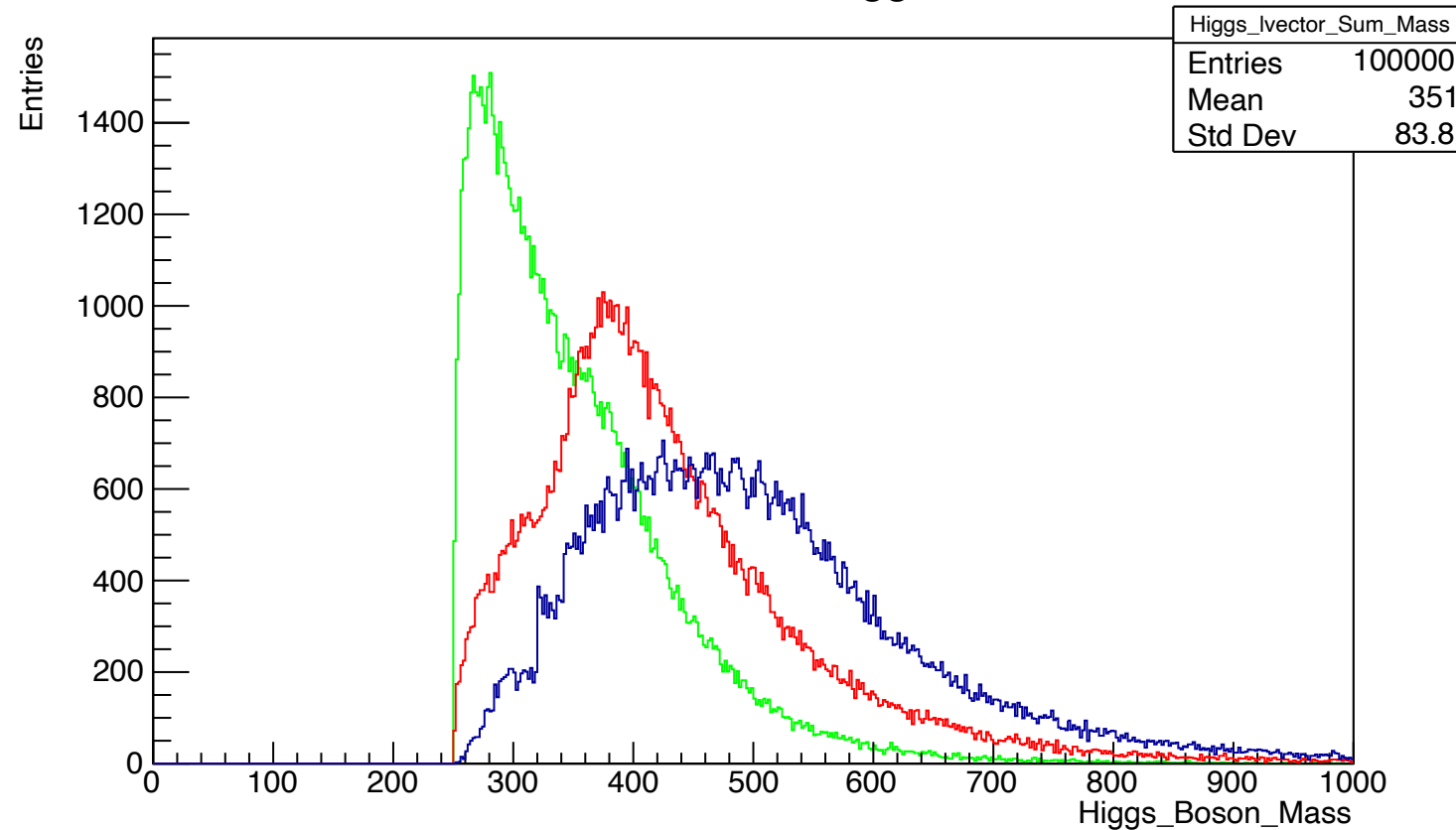

Data Quality

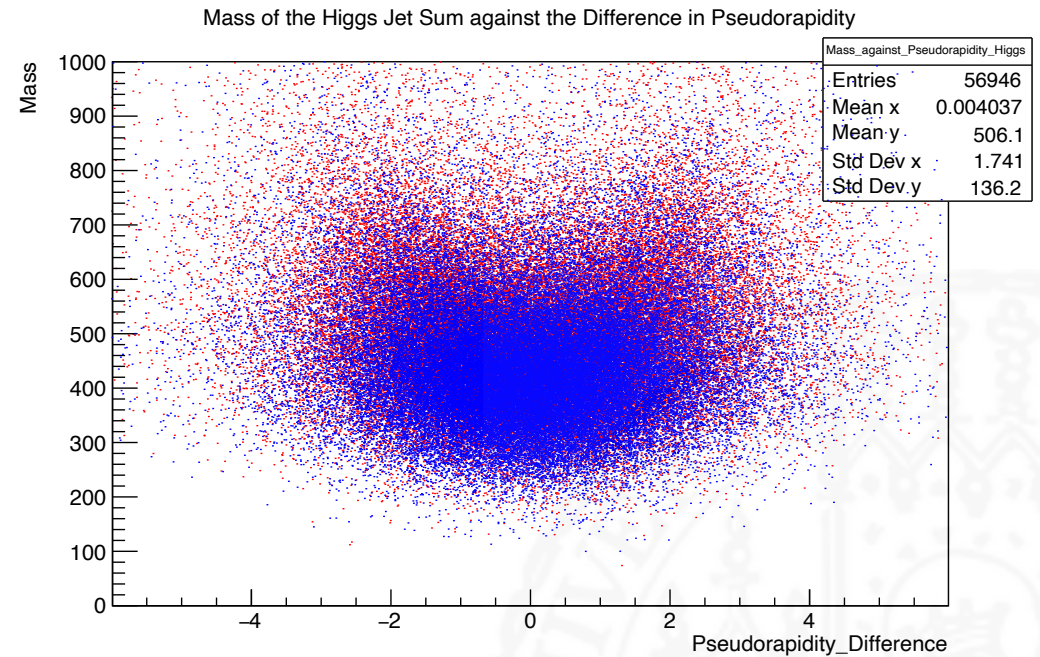
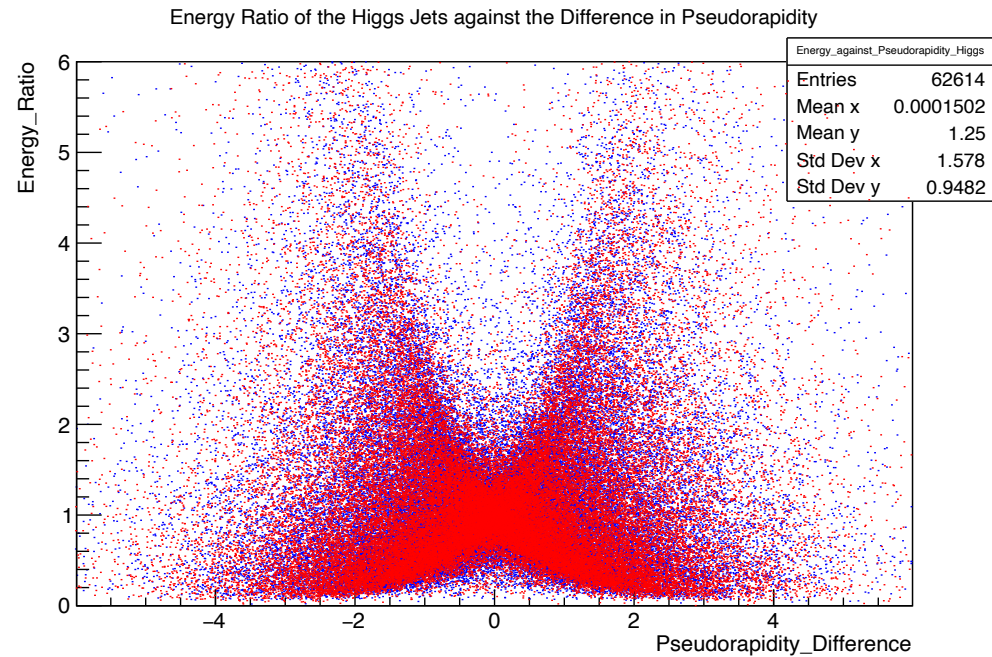

Current precision

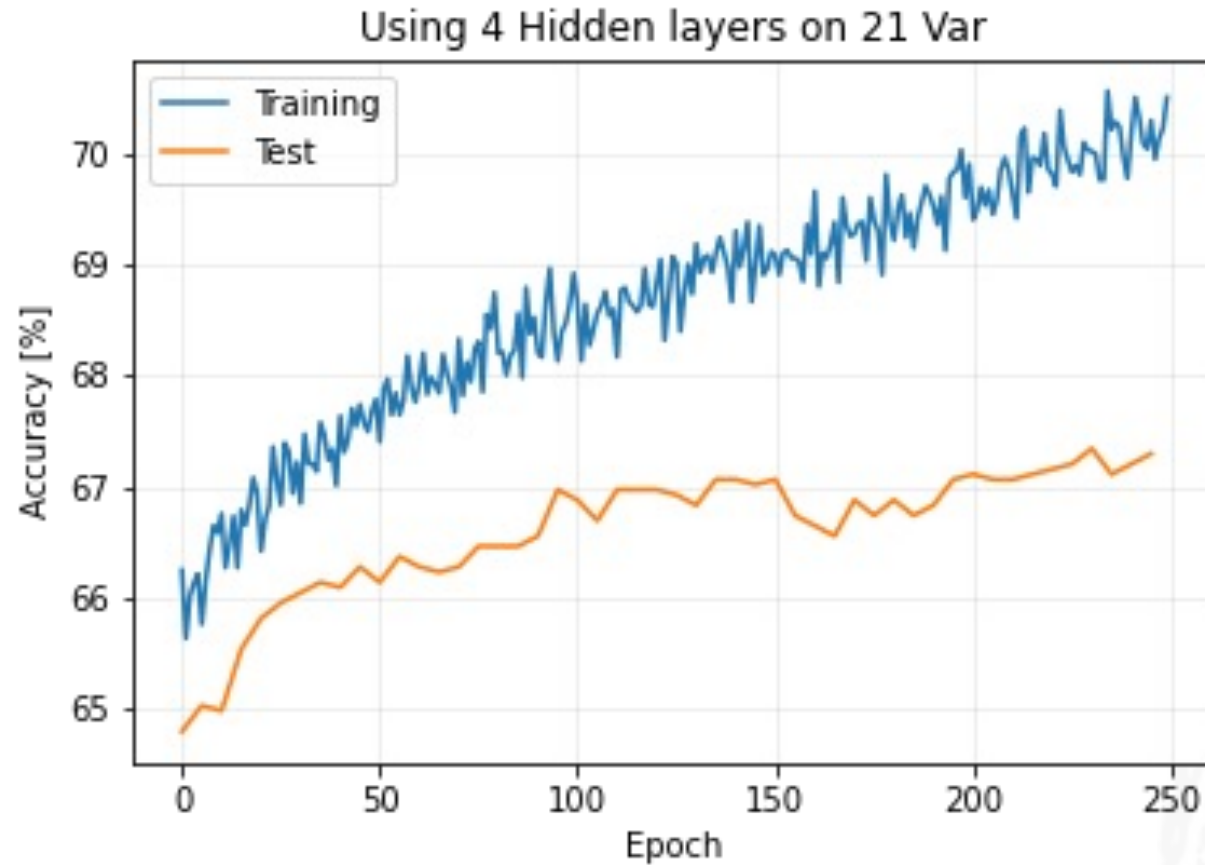

More Datasets

Mass of the Sum of the two Higgs Lorentz vectors

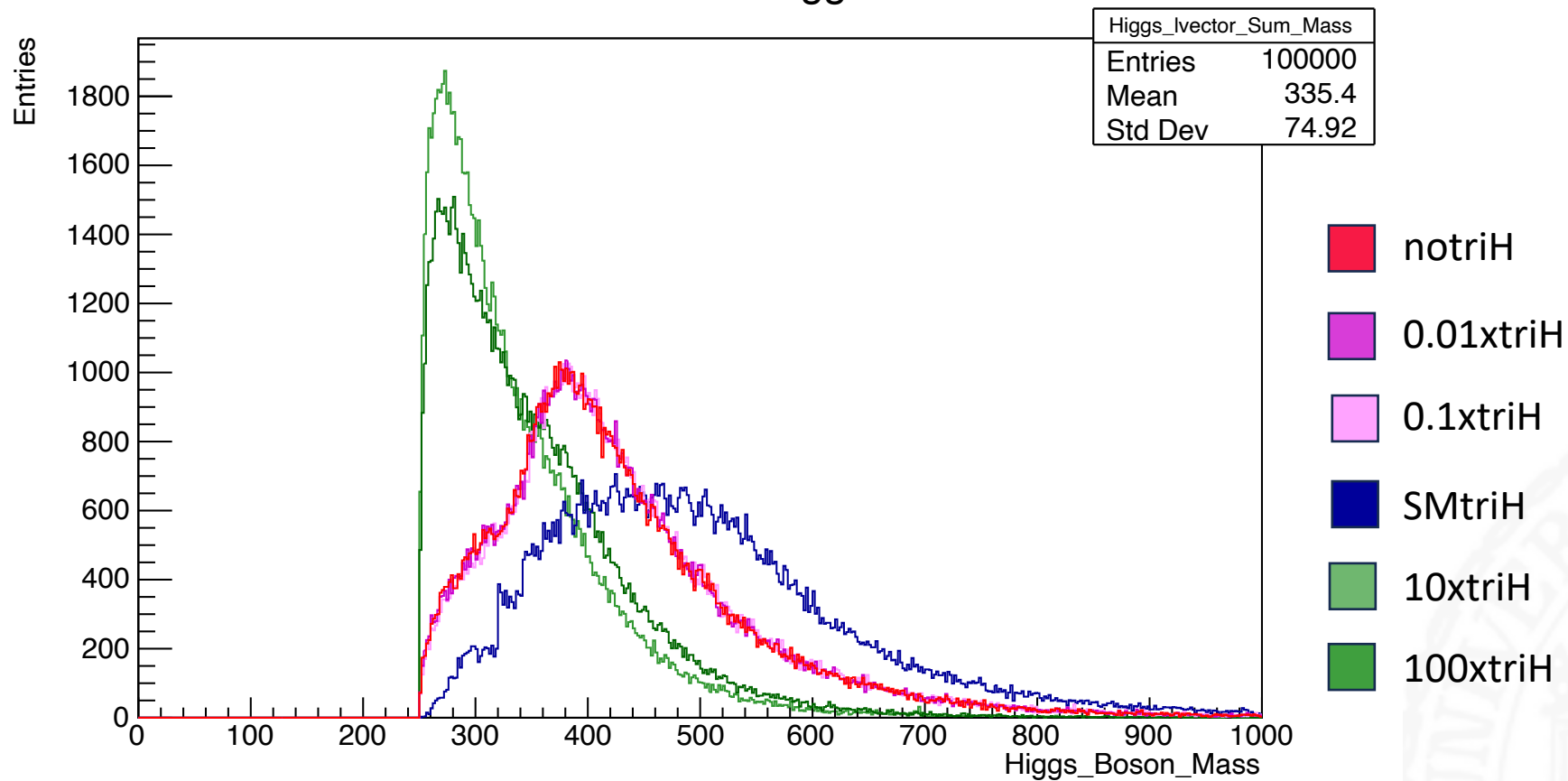

Current precision

